

# EDS660

Up to 95-pound Capacity Drying Tumbler

The EDS660 Dryer delivers unrivaled performance, programmability and efficiency in an up to 95-pound capacity, compact footprint. Smart construction keeps heat inside the dryer – shortening dry times, lowering utility costs and maximizing throughput. Features include intuitive graphic icons, 40 customizable programs, whisper-quiet operation and phased programming of moisture sensing and timed drying.



## Product Features

### Transflow

Pushes heated air through drum perforations from the top back to bottom front using airflow technology. Heated air then recirculates for the ultimate in fast, efficient drying performance.

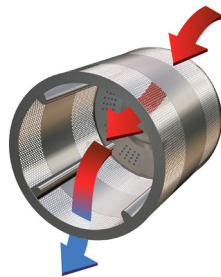

### Heat Capture Technology

Ensures dryer hits set temps quickly and keeps heat energy inside. Tight design with double glass window and reversible, wide door ensure no air leakage and quick drying.

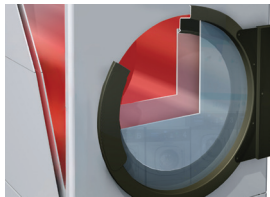

### Quiet, Robust, Gasket-Free Drum

The drum is constructed of durable galvanized and AISI 430 annealed stainless steel trunion supporters without rollers or joint seals, resulting in quiet operation, less mechanical wear and greater efficiency.

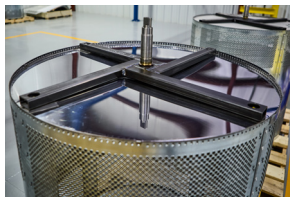

### Accessibility/Adaptability

Quick access to main components without complex disassembly. Reversible wide door.



### Programmability

Programmable drum rotation, Transflow, moisture sensing, timed reversing, auto cool-down, oven and drum temperatures, drum speeds, reversing on/off sequence and moisture levels. Manual changes on the fly, in mid cycle.

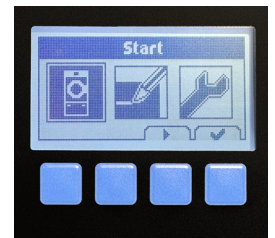

### Complete Speed Control

Drum Rotation Control delivers optional standard reversing and allows drum rotation speed adjustment to suit the residual moisture content or type of material being dried.

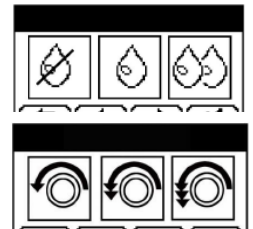

### AutoSpeed

This exclusive feature automatically adjusts cylinder speed to prevent tangling, delivering faster drying, better quality results and longer linen life.



### Durability and Efficiency

Robust structure with no efficiency loss over time. Components designed for intensive use, corrosion and temperature resistance and greater sustainability. Backed by a 5-year factory parts warranty.



# EDS660

Up to 95-pound Capacity Drying Tumbler

ARCHITECTURAL/MECHANICAL  
PRODUCT SPECIFICATIONS

Capacity <i>lbs</i>	up to 95
Cylinder Diameter <i>inch</i>	37
Cylinder Depth <i>inch</i>	37.4
Cylinder Volume <i>cu ft</i>	23.3
Net Weight <i>lbs</i>	760
Crated Weight <i>lbs</i>	807
Machine Dimensions <i>inch (WxDXH)</i>	38.6 x 53.3 x 72
Door Opening <i>inch</i>	28
Floor to Door <i>inch</i>	27.4
Shipping Dimensions <i>inch WxDxH</i>	40.6 x 57.1 x 78.1
Drum Motor Power <i>Hp</i>	1.14
Extraction Motor Power <i>Hp</i>	0.74
Exhaust Diameter <i>inch</i>	8
Exhaust Air Flow <i>cfm</i>	865
Gas Connection <i>inch</i>	1/2 NPT
Gas Heating <i>BTU/h</i>	133,074
Available Voltages/Wire Conductor/Amp (Rev Amp)	
Gas/LP	120/60/1, 2W+G, 15 208-240/60/1, 2W+G, 10 208-240/60/3*, 2W+G, 10 <small>*Third leg not used.</small>

\* 5-Year Factory Parts Warranty on all components except for belts and lint filter. Post warranty original manufacturer service parts are backed by an exclusive 1-year guarantee. See product warranty bond for complete warranty statement.

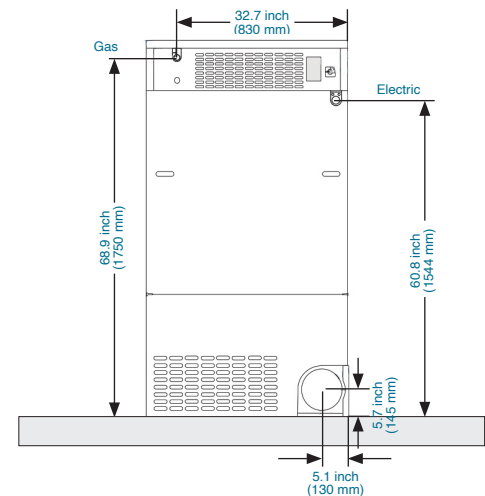
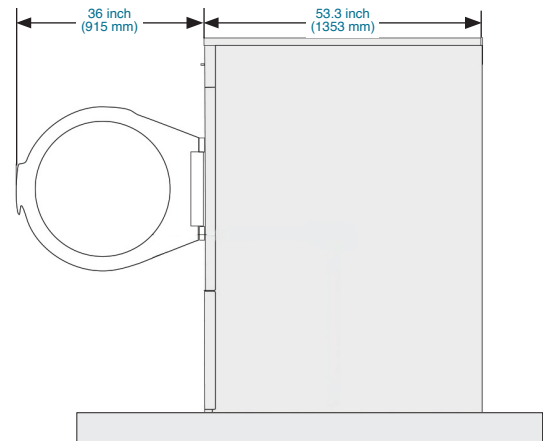
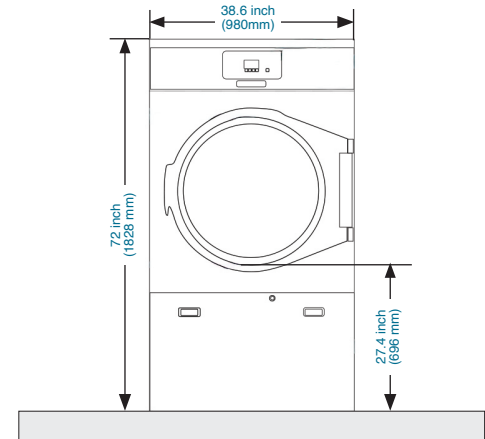

Scan for  
Digital Brochure



Specifications subject to change without notice or obligation. Contact Continental Laundry Solutions at (800) 256-1073 for dimensions not shown or for clarification.

poseidontextilecare.com • (800) 256-1073



GIRBAU COMMERCIAL  
LAUNDRY PRODUCTS  
provided exclusively by

